

! CAUTION

- All wiring should be done by a licensed electrician in accordance with state codes, local codes and National Electric Code (NEC) standards.
- Improper installation may result in serious injury and void warranty.
- May contain parts and assemblies susceptible to damage by electrostatic discharge (ESD).

Mounting

Fasten fixture with four (4) 3/8 inch (10 mm) diameter screws through holes provided in the mounting feet on the main housing.

In applications where vibration is present, do not mount fixture on surface that is unsupported or is subject to flexing.

The fixture is not designed to be used in upright positions.

Mounting Hole Location

2 foot fixture

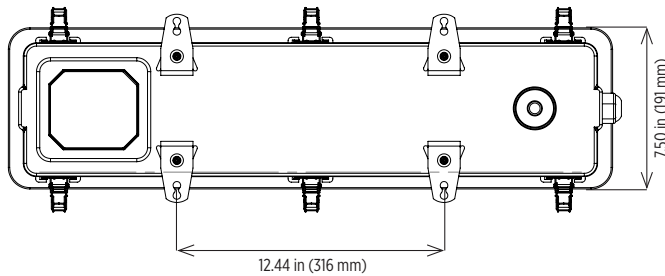

4 foot fixture

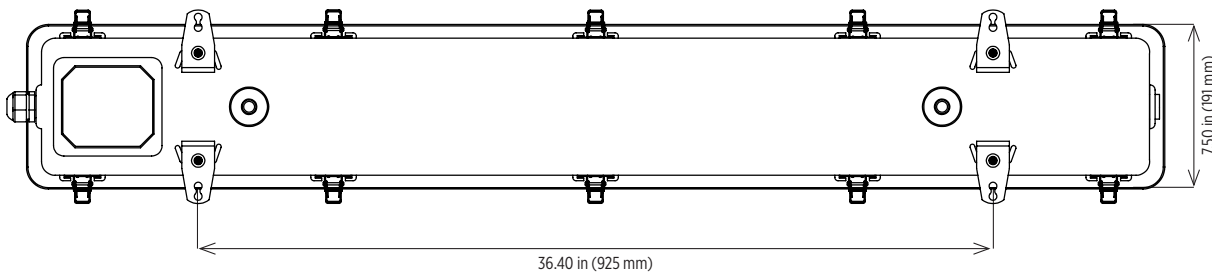

LED Access

To access the LED compartment, loosen the diffuser and allow it to hang freely by its tethers.

Routine cleaning is recommended for the diffuser cover so the fixture maintains photometric efficiency.

Wiring

Electrical fittings and connectors appropriate for the application and in compliance with accepted codes must be used. The green conductor is grounded to the fixture and must be connected to a positive ground.

Do not connect green (ground) wire to power source.



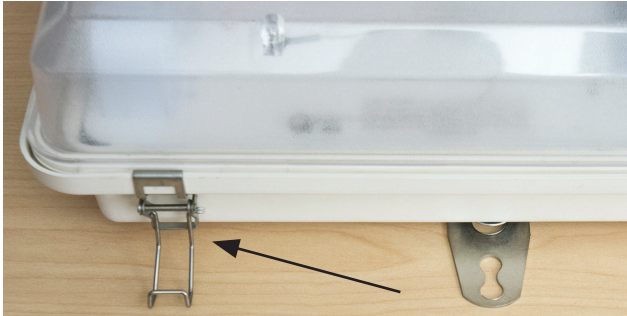

1. Remove lens by releasing latches that secure the lens. The lens will suspend by the tethers inside the fixture.

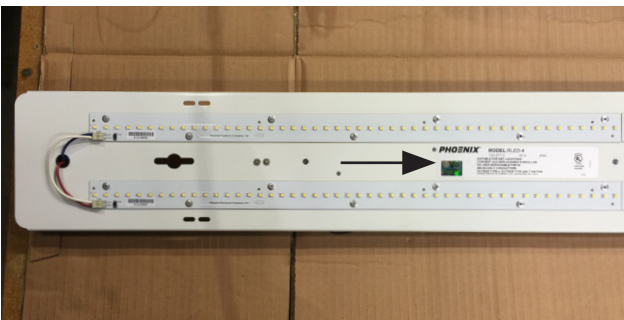

3. Electrical voltages and frequency are listed on the driver tray for reference.



CAUTION: This Unit Has More Than One Power Supply Connection Point. To Reduce The Risk Of Electric Shock, Disconnect Both



CAUTION: This Unit Has More Than One Power Supply Connection Point. To Reduce The Risk Of Electric Shock, Disconnect Both

2. Twist wing nuts ¼ turn counterclockwise to release the driver tray from the housing.

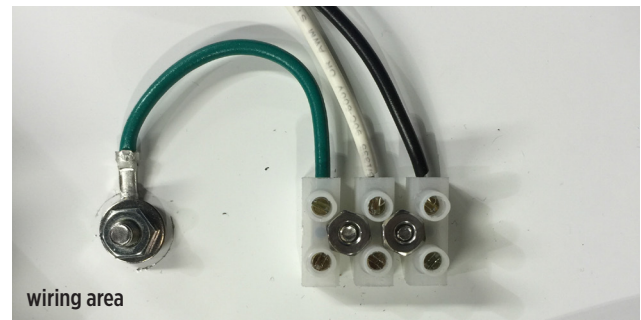

wiring area

4. Connect power supply leads to terminal block (if supplied) or directly to the black and white driver box.



wiring area

5. Connect green (ground) power supply lead opposite green lead.



wiring area

6. Connect white (neutral) power supply lead opposite white lead.



wiring area

7. Connect black (line) power supply lead opposite black lead.

Dimming

All ReadLED fixtures are supplied with 0-10V dimmable drivers. Purple is DIM (+) and gray is DIM (-).

To dim fixtures,

1. Cut off wire caps from driver dimming leads and strip back the wire insulation 5mm.
2. Using the customer-supplied dimming cable, extend the two dimming (+/-) leads to the driver.
3. Reconnect correct leads using either two-position quick connectors or crimp connectors.

! IMPORTANT SAFEGUARDS

- To prevent high voltage from being present on driver output leads prior to installation, inverter connector must be open. Do not join inverter connector until installation is complete and AC power supply is connected to the emergency driver.
- To reduce risk of shock, disconnect both normal and emergency power supplies and inverter connector of the emergency driver before servicing fixture.
- Do not attempt to service battery alongside emergency driver.
- When using electrical equipment, basic safety precautions should always be followed including the following:

READ AND FOLLOW ALL SAFETY INSTRUCTIONS.

- Do not mount near gas or electric heaters.
- Equipment should be mounted in locations and at heights where it will not readily be subjected to tampering by unauthorized personnel.
- The use of accessory equipment not recommended by the manufacturer may cause an unsafe condition.
- Do not use this equipment for other than intended use.
- Maximum mounting height is 17 feet (5.2 m).

SAVE THESE INSTRUCTIONS.

Installation of Fixtures with Emergency Drivers (EMB suffix)

For supply connections, use wire suitable for at least 90°C.

An unswitched power supply must be available for emergency driver use. The unswitched lead must be fed from the same branch circuit as the switched lead.

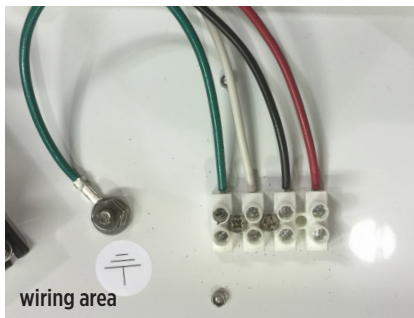

1. Connect power supply leads to terminal block (if supplied) or directly to the black and white driver box.

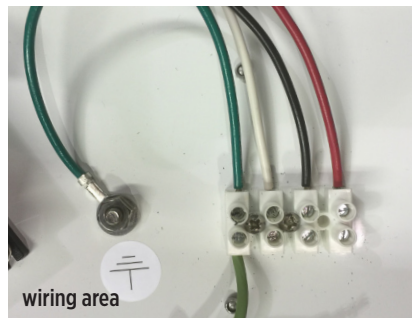

2. Connect green (ground) power supply lead opposite green lead.

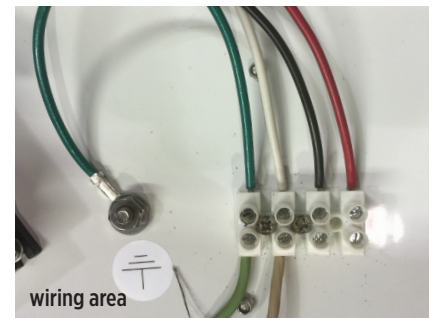

3. Connect neutral (common) power supply lead opposite neutral lead.

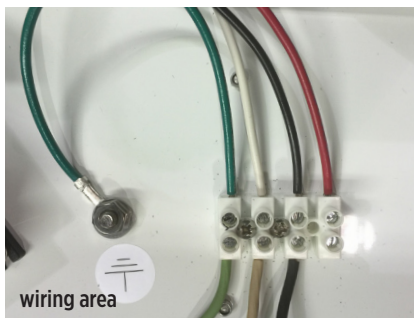

4. Connect unswitched incoming (hot) lead to black lead.



5. Connect switched incoming (hot) lead to red lead.



6. Join inverter connection (with integral plug/receptacle) of emergency driver after connecting incoming leads.

7. Charge unit for 24 hours before use.



Operation of Emergency Driver

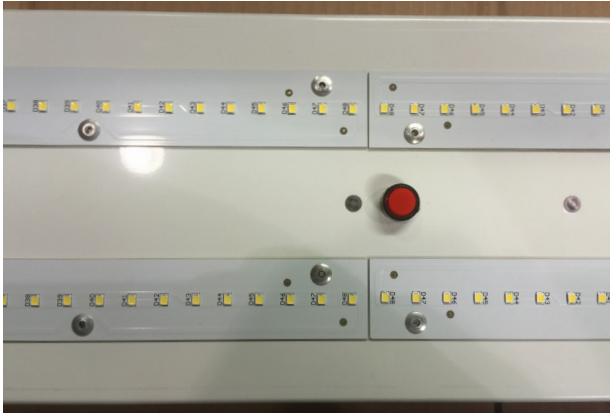

When AC power is applied, the charging indicator is illuminated, indicating that the battery is being charged.

When power fails, the emergency driver automatically switches to emergency power (battery pack). The fixture will then operate one LED strip at reduced illumination for at least 90 minutes.

A spot test of emergency driver function may be performed by removing lens and depressing test switch on lamp side of the reflector.

One strip should operate at reduced illumination while the switch is depressed.

For additional information, please refer to EMB system installation instructions provided.

Repair Parts

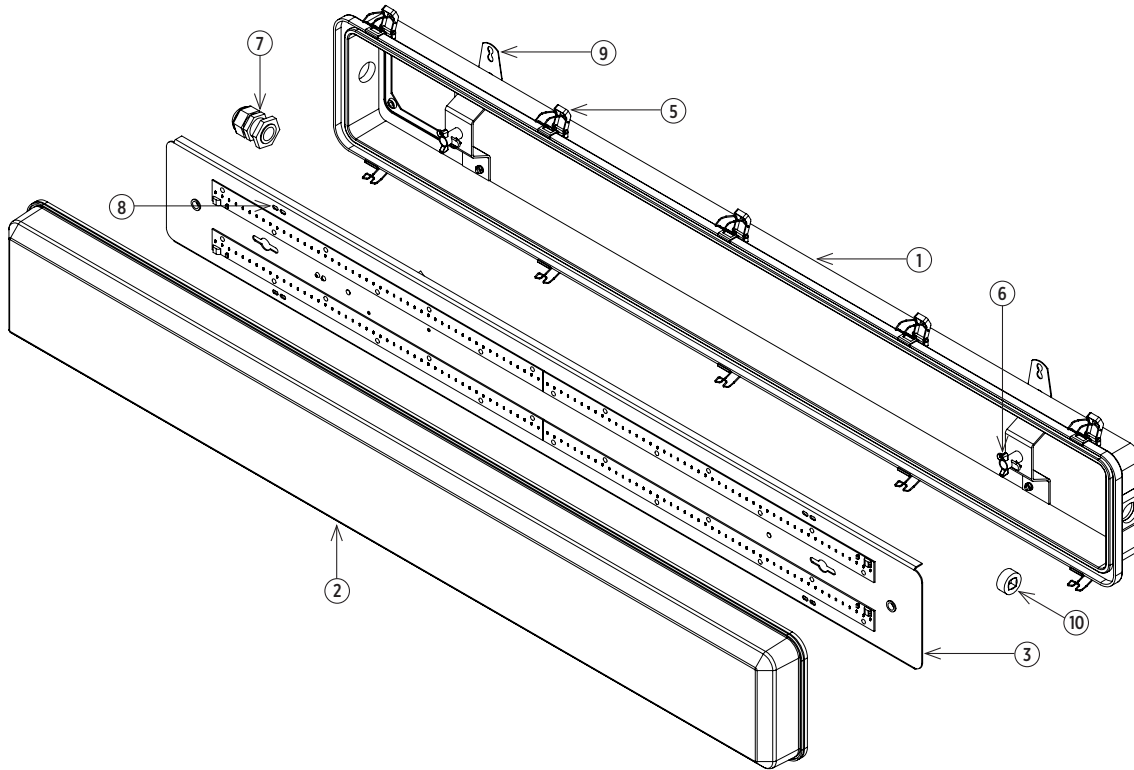

Item	Quantity	Description	Part Number	
			2 Foot Units	4 Foot Units
1	1	housing assembly	1650495	1650510
2	1	diffuser	1650320	1650420
3	1	driver tray	contact factory	
5	6	latch assembly	1650311	
	10			
6	2	driver tray fastener assembly	1650312	
7	1	cord grip	4030700	
8	4	lanyard	4131201	
9	2	mounting feet	1650313	
10	1	threaded plug	4025422	
11	1	driver	contact factory	
12	2	ground wire	4124300	

