



Introducing the third generation of the proven EcoMod[®] Series
 Expertly engineered with durable, marine grade components and various optic options
 Numerous bracket options to easily retrofit to existing hole patterns
 Custom designed, high temperature optics improve safety, increase efficiency and maximize operator comfort

Key Applications

- Ship-to-Shore (STS) cranes
- Rubber Tired Gantry (RTG) cranes
- Mobile harbor cranes (MHC)
- Interior and exterior uplighting
- Facility and perimeter lighting
- Deck flood lighting
- Airport hangars
- Overhead cranes
- Bridges and parking lots
- Aft wheelhouse lighting
- Vessel perimeter lighting

Compliances

ETL/cETL Certified to:

- UL 1598 Suitable for Wet Locations
- UL 1598A Marine Outside Type (Saltwater)
- CSA C22.2 No. 250.0

CE

IP66, IP67 and IP69K

ABS

DLC (contact factory)

LM79 and LM80 reports available

FCC Part 15, Subpart B, Class A standards for conducted and radiated emissions.

Buy American Act (BAA)

Build America Buy America Act (BABA)

Specifications

Construction	Marine grade, powder coated cast aluminum housing Adjustable powder coated steel mounting harp
Finish	Black thermoset powder coat 2-step finish

Specifications

Hardware	Marine grade (316) stainless steel
Lens	Clear, tempered glass
Surge protection	20kV (20kA)
Light source	Up to 15,000 lumens, 121W (LO); 30,000 lumens, 231W (HI); 52,500 lumens, 438W (MAX) Cool white 5000K (50K), neutral white 4000K (40K), warm white 2700K (27K) LED options CRI > 70 50,000 hour rated life
Power source	120-277V, 50-60Hz; 277-480V, 50-60Hz Overload, over-voltage, over-temperature and short-circuit protection 0-10V dimming option (DIM)
Wiring	Stranded wires 17 gauge, 3 conductor cord - 72.00 inch (1829 mm) with pigtail - standard Through wire optional (TW) (no cord provided) Standard cord grip 0.37 inch - 0.50 inch (9.5 mm - 12.7 mm)
Ambient operating temperature	-40°C to + 60°C (LO & HI models) -40°C to + 50°C (MAX model)
Mounting	Indexed aiming and lockable in 5° increments Alternative brackets to match legacy hole patterns (B1 and B2) Boom mount kit and tenon mount kit accessories (sold separately)
Vibration	6G at resonant frequency
Weight	LO - 31.0 lb (14.1 kg) HI - 39.6 lb (18.0 kg) MAX - 49.2 lb (22.3 kg)
Safety cable	Safety cable included
Warranty	5 years



This product complies with domestic preference requirements such as BABA. For additional information, visit phoenixlighting.com or consult your representative.



This product complies with domestic preference requirements such as BAA or TAA. For additional information, visit phoenixlighting.com or consult your representative.

For IES files, see website or contact factory

EcoMod® 3 Series

Heavy Duty LED Floodlight

PHOENIX®
DURABILITY X DESIGN™

Dimensions (Standard Mounting Brackets)

LO Model

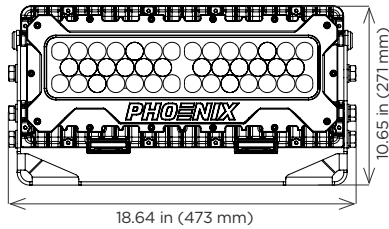

HI Model

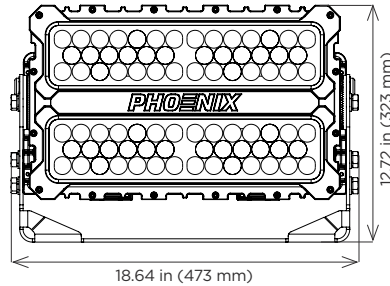

MAX Model

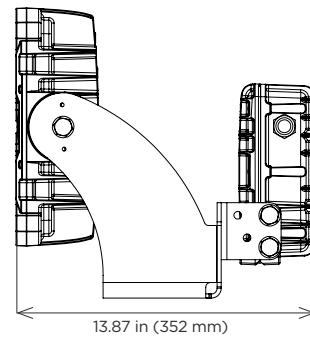
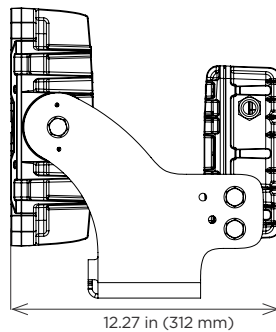
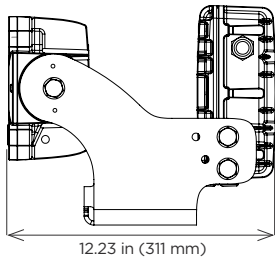
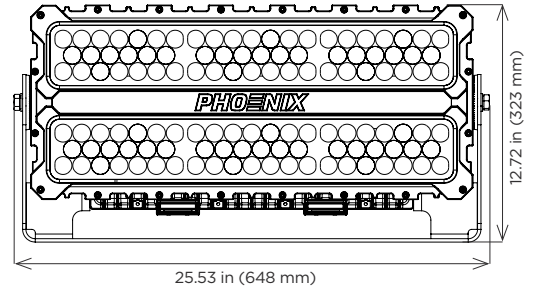

LO & HI Model

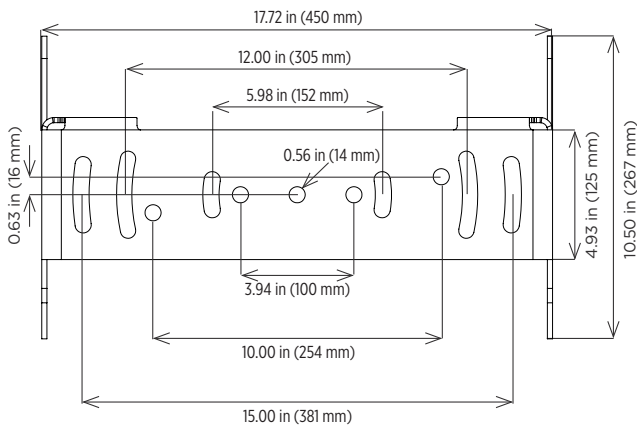

MAX Model

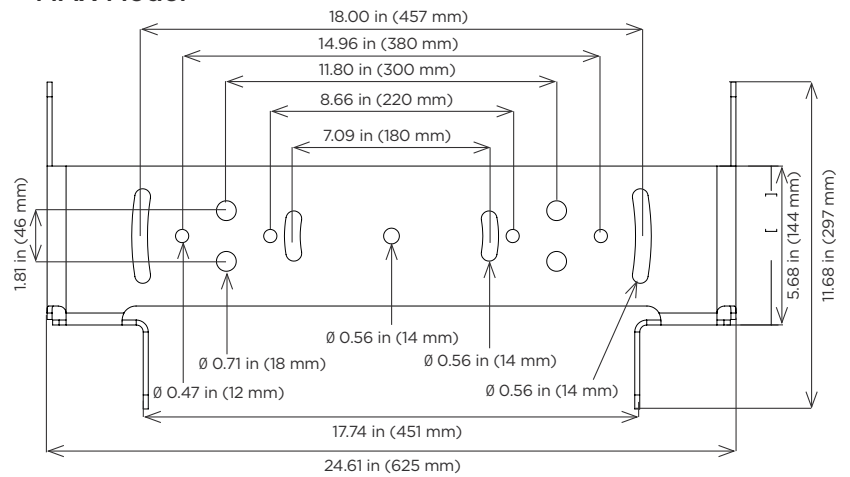

Dimensions (Alternative Brackets B1 & B2)

LO Model (B1)

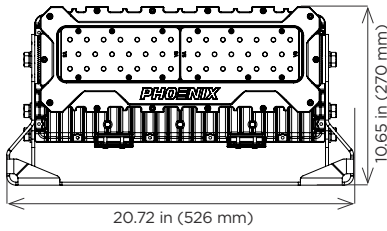

LO Model (B2)

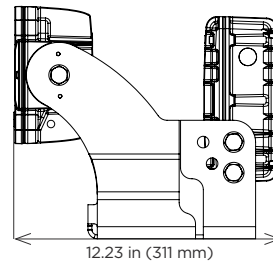
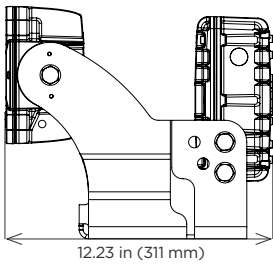
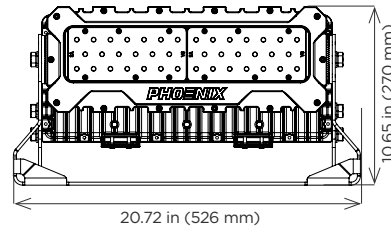

LO Model (B1)

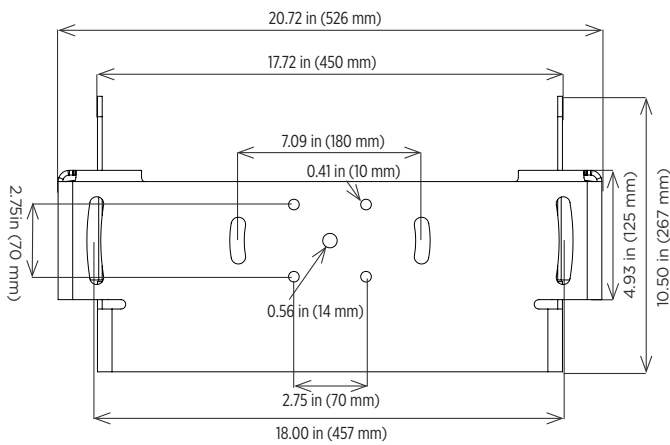

LO Model (B2)

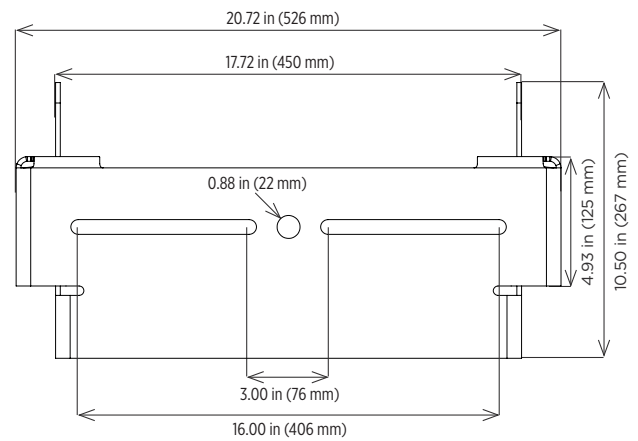

EcoMod® 3 Series

Heavy Duty LED Floodlight

PHOENIX
DURABILITY X DESIGN™

Dimensions (Alternative Brackets B1 & B2)

HI Model (B1)

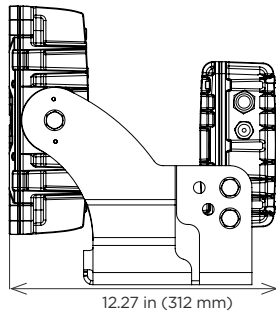
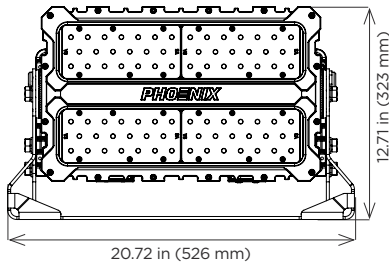

HI Model (B2)

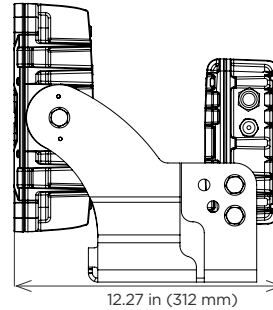
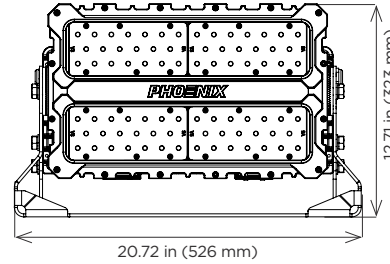

HI Model (B1)

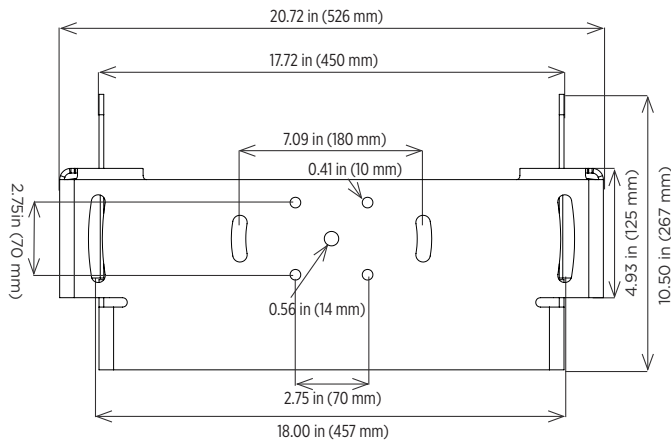

HI Model (B2)

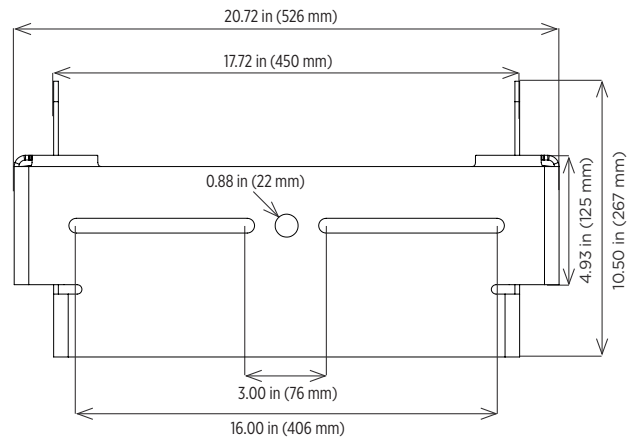

MAX Model (B1)¹

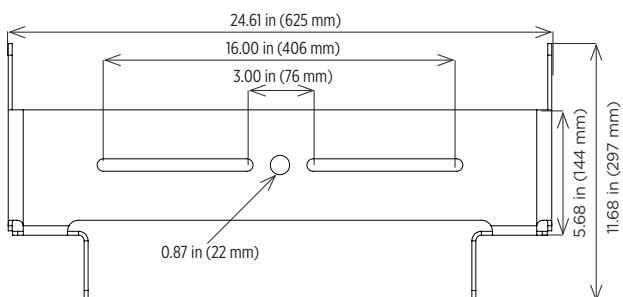

Notes

- 1 EM3-MAX-B1 height and width are same as the standard EM3-MAX.

Ordering Information

Example: EM3-HI-MF-120-277-50K-DIM

Fixture	Model	Optic	Voltage	Color Temperature	Options	Alternative Brackets
EM3	LO	WF	120-277	50K	DIM ²	B1
	HI	MF	277-480	40K ¹	TW ²	B2 ³
	MAX	WS		27K ¹		
		SP				
		NS				
		VS				
		NG				

Model

LO up to 15,000 lumens, 121W
 HI up to 30,000 lumens, 231W
 MAX up to 52,500 lumens, 438W

Optic

WF Wide flood
 MF Medium flood
 WS Wide spot
 SP Spot
 NS Narrow spot
 VS Very narrow spot
 NG No-glare/perimeter

Voltage

120-277 120-277V, 50-60Hz
 277-480 277-480V, 50-60Hz

Color Temperature

50K Cool white 5000K LEDs
 40K¹ Neutral white 4000K LEDs
 27K¹ Warm white 2700K LEDs

Options

DIM² Dimmable (0-10V)
 TW² Through wire

Alternative Brackets

B1 Alternative bracket 1
 B2³ Alternative bracket 2

Notes

- 1 Contact factory for availability/more information
- 2 DIM & TW are not available together
- 3 B2 bracket only available on LO and HI models

Special Projects: We may be able to accommodate your special projects, so please don't hesitate to ask about additional options. Minimum order quantities and/or extended lead times will apply. Contact your Phoenix representative with specific inquiries.

Optics Chart

Optic	Description	Nema	Field Spread	HWHM
WF	Wide Flood	7H X 6V	113.6°V x 138.6°H	33°
MF	Medium Flood	5H X 5V	84.9°V X 88.5°H	22°
WS	Wide Spot	5H X 5V	67.0°V x 68.4°H	15°
SP	Spot	4H X 4V	54.2°Vx 55.5°H	12°
VS	Very Narrow Spot	2H X 2V	24.3°V X 24.8°H	7°
NG	No Glare Perimeter	5H X 4V	59.7°V X 74.6°H	32°

Accessories (order separately)

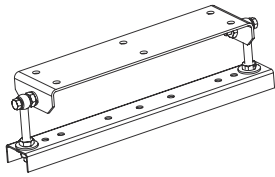

Boom Mount Kit
BMK-LO/HI/MAX

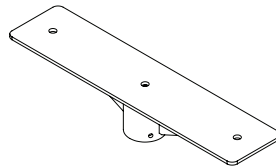

2 ¾ inch Tenon Mount
PTM-LO/HI (LO & HI models only)
PTM-MAX (MAX models only)

Isolux Charts

EM3-HI-WF - Wide Flood

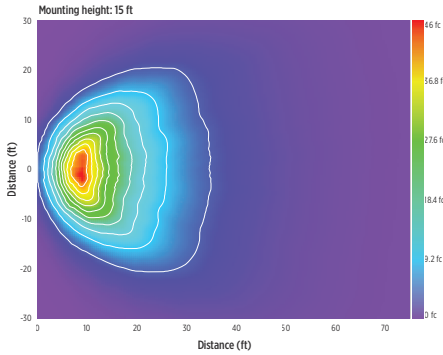

EM3-HI-MF - Medium Flood

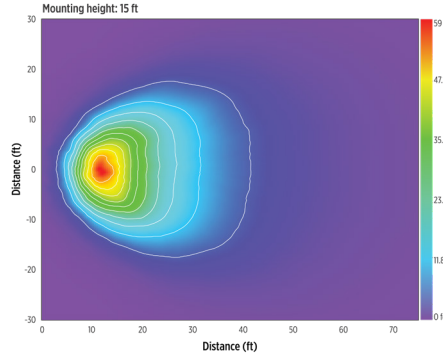

EM3-HI-WS - Wide Spot

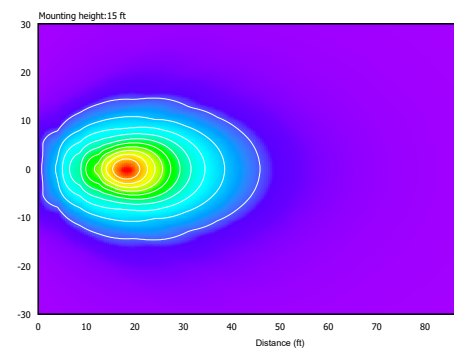

EM3-HI-SP - Spot

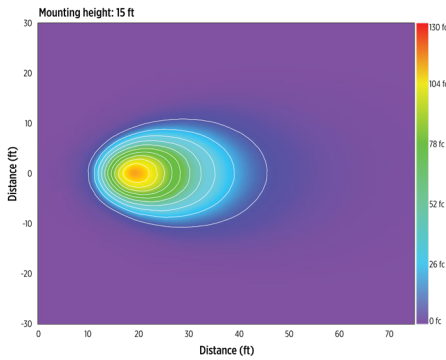

EM3-HI-VS - Very Narrow Spot

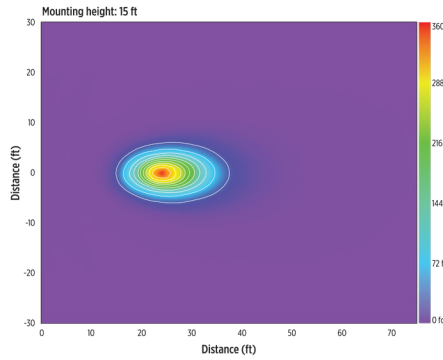

EM3-HI-NG - No-Glare

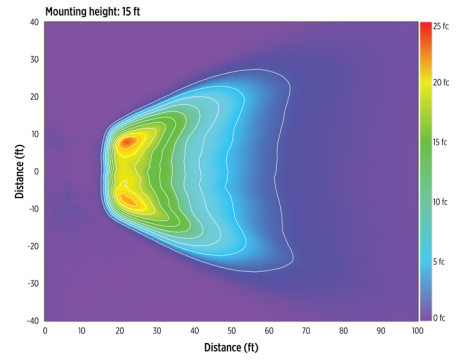

Product design and specifications are subject to change without notice. The most current version of this specification sheet can be found at www.phoenixlighting.com.